

RTX3 Wireless Expansion Module V5.3

P ▲ R ▲ D O X™



Reference and Installation Manual

Table of Contents

Specifications.....	3
Hardware Compatibility.....	3
Overview	4
Description	4
Features	4
Installation	6
Antenna Installation	7
System Reset.....	7
LED Feedback	8
Programming	9
Programming RTX3 for Spectra SP Series Panels.....	9
Programming for EVO Series Panels.....	9
Programming Stand-Alone RTX3 Modules	17
Firmware Upgrade	20
Index	21

Specifications

Power input voltage:	12Vdc
Frequency:	433MHz or 868MHz
Sensitivity:	-120 dBm
Current consumption:	50 mA
Dimensions and Weight:	15cm x 16cm x 3cm (6in x 6.5in x 1.1in) / 24g
Operating temperature:	0°C to 49°C (32°F to 120°F)
Humidity:	5 - 90%
PGM outputs:	PGM1 and PGM2 - 150mA PGM transistor outputs PGM3 - form C relay output rated at 5A/28Vdc, N.O./N.C. (PGM4 optional)
Range:	Refer to the appropriate transmitter <i>Instructions</i>
Other:	Di-pole antenna; Error Correction Algorithm
Approvals:	EN50131-3: Security Grade 2, Environmental Class II, Certification Body Intertek For the latest information on product approvals, visit our website at www.paradox.com

Hardware Compatibility

	EVO	Spectra SP	Stand Alone
Zones	32	32	32
Remotes	32/96/999	32	32
Remote Control Type	REM1 RAC1 REM2 RAC2 REM3 REM15	REM1 RAC1 REM2 RAC2 REM3 REM15	REM1 REM15
Wireless PGMs	8	16	-
Wireless Keypads	-	8	-
Wireless Siren	8	4	-
Wireless Repeater	-	2	-
PX8 Output Module	-	-	4

Overview

This chapter provides an overview of the RTX3 Wireless Expansion Module (“RTX3”), including the package contents provided with the RTX3, the system features and an overview of the RTX3 components.

Description

The RTX3 is a 2-way, 32 zone wireless expansion module which enables EVO and Spectra SP Series control panels to support wireless hardware such as sirens, motion detectors and remote controls.

Included Items Antenna
Required/Optional Items <ul style="list-style-type: none">• Mounting hardware• Optional 12Vdc external power supply (PS17)
Compatibility <ul style="list-style-type: none">• EVO 192 / EVOHD control panels• Spectra SP series control panels

Features

- Up to 32 wireless zones
- Support for REM1 / REM2 / REM3/ REM15 / RAC1 / RAC2 remote controls
- Support for wireless PGMs
- Support for all Magellan transmitters including 2WPGM
- Support for two RPT1 and eight K32RF / K37 (SP Series only)
- Support for SR130 / SR150 Wireless Sirens and RPT1 Wireless Repeater (EVO and SP Series)
- Support for PX8 Output Module
- In-field firmware upgrade through BabyWare software via serial or 4-wire connection
- RF jamming supervision
- Low battery, tamper and check-in supervision
- Transmitter signal strength display
- 3 PGM outputs and 1 optional output
- Noise level test and indicator

RTX3 Board and Connectors

The following graphic displays the RTX3 board and connectors.

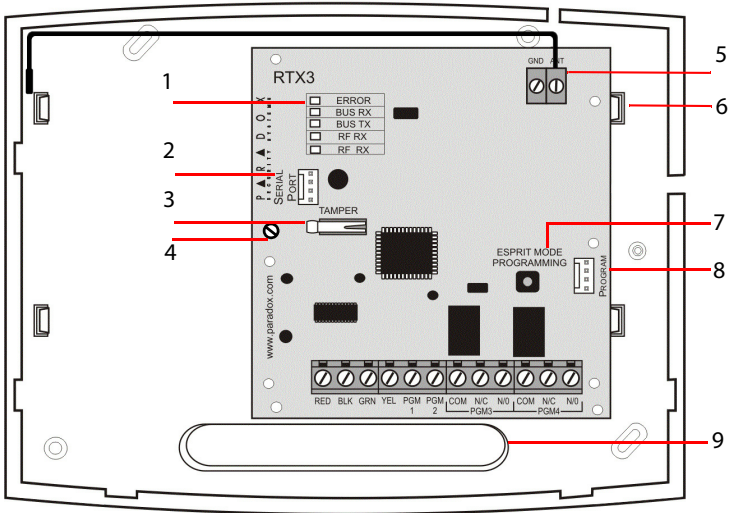

Figure 1: RTX3 Board and Connectors

<ol style="list-style-type: none"> 1. LED display (see LED Feedback on page 8) 2. Firmware upgrade serial connector (see Firmware Upgrade on page 20) 3. Anti-tamper switch 4. PCB screw 5. Antenna 6. Mounting clips 	<ol style="list-style-type: none"> 7. Mode Programming button: Used for programming Stand Alone RTX3 modules (see Stand Alone Programming on page 17 and System Reset on page 7) 8. Program connector: Connect the keypad to the Program connector to program in Stand Alone mode 9. Wiring slot
---	---

Chapter 1: Installation

This section describes how to connect the RTX3.
The following diagram displays RTX3 installation.

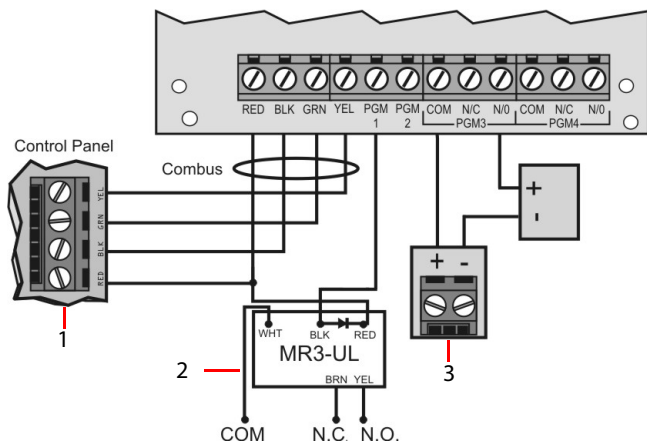

Figure 2: RTX3 Installation

1. Control panel Digiplex connection.

Notes:

- When using the RTX3 as a stand-alone device: connect an external 12Vdc power supply to the RED and BLK terminals
 - Battery backup is recommended
2. Use a relay if the current draw exceeds 150mA on PGM1 or PGM2. Connect the RTX3's RED connector to the relay's RED connector, and the RTX3's PGM connector (PGM1 or PGM2) to the relay's BLK connector.
 3. Connect PGM3 and PGM4 to external power supplies if additional power is required. A PS-817 is recommended. Connect the PGM's N/O connector to the external power supply's "+" connection. Connect the power supply's "-" connector to the device's "-" connector. Connect the PGM's COM connector to the device's "+" connector.

Note: Write down the serial number of all wireless modules used with the RTX3.

Antenna Installation

Secure the antenna to the **ANT** terminal connector as displayed below.

Note: A 433 MHz antenna is displayed.

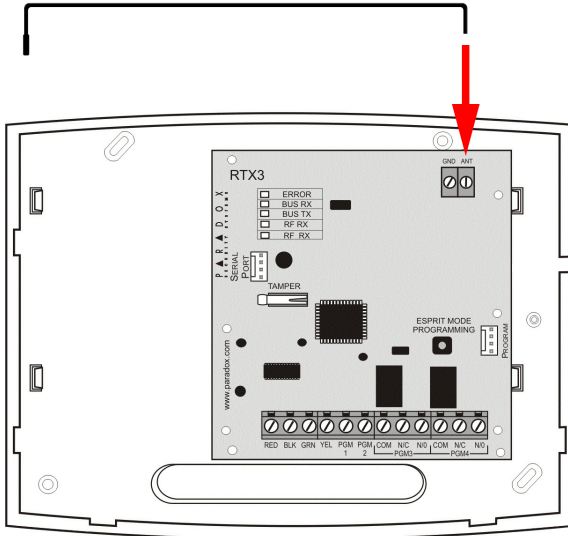

Figure 3:Antenna Connection

System Reset

System Reset restores the RTX3 factory settings.



IMPORTANT: System Reset only functions during the first 30 seconds after RTX3 power up.





To reset the system:













1. Press and hold the **Programming** button for 5 seconds.
The **BUS RX** LED flashes (see [LED Feedback](#) on page 8).
2. Release the button and press it again while the LED flashes to reset the RTX3 default settings.

LED Feedback

The following tables display LED feedback.

Legend	
R = Red	 = Off
G = Green	 = On
Y = Yellow	 = Flashing

ERROR  Problem with the module
BUS RX  Receiving from panel
BUS TX  Transmitting to panel
RF RX  Receiving wireless
RF TX  Transmitting wireless

ERROR  Com fail: GRN/YEL
BUS RX  short / no data
BUS TX 
ERROR  Com fail: too many modules / wrong data
BUS RX 
BUS TX 
ERROR  Com fail: GRN/YEL reversed
BUS RX 
BUS TX 
ERROR  Combus power too low
BUS RX 
BUS TX 

Chapter 2: Programming

This section describes how to program the RTX3 for Spectra SP series control panels, EVO series control panels and for stand-alone installations.

Programming RTX3 for Spectra SP Series Panels

When connected to a Spectra SP Series control panel, RTX3 settings are programmed through control panel programming sections. For detailed instructions refer to the *Spectra SP Series Programming Guide*.

Notes:

- Programming for a Spectra SP series system requires K32 or K10V/H keypads v2.0 or higher
- Only one RTX3 module can be connected to a Spectra SP Series panel

Programming for EVO Series Panels

Program RTX3 settings for EVO panels with either a keypad or BabyWare PC software.

Programming RTX3 with a Keypad

When connected to an EVO panel, program RTX3 settings through the keypad by entering Module Programming Mode.

To enter Module Programming mode:

1. Press and hold the **[0]** key.
2. Enter the **[INSTALLER CODE]**.
3. Enter section **[4003]**.
4. Enter the module **[SERIAL NUMBER]**.
5. Enter the required **[DATA]**.

Note: When used without a K641 or K641R keypad, enable EVO option **[1]** in section **[3029]**.

After Programming RTX3 for EVO Control Panels

Program the zones, PGMs, sirens and remote controls into the EVO panel. Refer to EVO section **[3034]** and RTX3 section **[001]*** options **[2]** and **[3]** for wireless transmitter supervision options. **Requirement:** Configure all wireless sirens in an EVO system to a single RTX3.

* For instructions on entering 3-digit RTX3 section numbers see [RTX3 Programming Sections for EVO Panels](#) on page 10.

RTX3 Programming Sections for EVO Panels

Section	Feature	Details
[001]	Option	
	[1]	Low battery supervision For RTX3 version 1.5 and higher, this option is always on ON: default
	[2]	Check-in supervision OFF: default
	[3]	Check-in supervision time interval OFF: 24 hours (default) ON: 80 minutes
	[4]	RF Jamming supervision OFF: default
	[5]	On-board module tamper supervision OFF: default
	[6]	PGM1 initial state OFF: Normally Open (default) ON: Normally Closed
	[7]	PGM2 initial state OFF: Normally Open (default) ON: Normally Closed
[8]	Transmit tamper signal OFF: RTX3 ignores tamper signal (default) ON: RTX3 reports tamper signal	
[002]	Remote Control Options	
	[1]	REM2 visual and auditory feedback compatibility options* OFF: Old visual and auditory feedback (Supported by REM2 v2.00 or lower) ON: New visual and auditory feedback (default) Note: Requires REM2 v2.01 and higher

Section	Feature	Details
	* The new visual and auditory feedback includes the following system status: stay armed, instant armed and exit delay. Other status feedback has not changed. For REM2 v1.04 or older, stay arm, instant arm and exit delay status are not supported, and a rejection beep will be heard when the system is in these status.	
[030]	View Transmitter, Remote Control and PGM Serial Numbers	To view a transmitter's 6-digit serial number: Press and hold the transmitter's anti-tamper switch
See Details	Remote Controls	To program remotes controls: <ul style="list-style-type: none"> Refer to <i>User Code</i> and <i>Remote Control Programming</i> sections in the <i>EVO Programming Guide</i> OR: Program through BabyWare Note: When programming remote controls (excepting a DSP series keypad) for a system, enable EVO option [1] in section [3029] and refer to <i>RTX3 Remote Control Programming for EVO</i> on page 15
[601] to [632]	<i>Transmitter signal strength</i>	[601] = Zone input 1 [632] = Zone input 32 3 or less = weak (move transmitter) 4 to 10 = OK
[701] to [732]	<i>Current battery life</i>	[701] = Zone input 1 [732] = Zone input 32 View number of weeks the batteries have been in the transmitter.
[801] to [832]	<i>Previous battery life</i>	[801] = Zone input 1 [832] = Zone input 32 View number of weeks the previous batteries were in the transmitter

Section	Feature	Details
[671] to [678]	2WPGM Signal Strength	Sections [671]-[678] correspond to Zone inputs 1 - 8 Signal Strength: <ul style="list-style-type: none"> • 3 or less: weak - move transmitter • 4 to 10: OK
[901] to [908]	Assign 2WPGMs	Sections [901]-[908] correspond to Zone inputs 1 - 8 To assign 2WPGMs: Enter a 6-digit serial number or press and release the transmitter's tamper switch To delete an assigned 2WPGM: Enter 000000 as a serial number Note: If a section between [901] to [904] is empty, the RTX3 uses the on board PGM
[910] to [989]	PGM Programming	To program Two-Way PGM activation event, deactivation event and PGM Delay options, see <i>RTX3 PGM Options for EVO</i> on page 14
[991]	View two-way PGM Tamper Trouble	PGM # in tamper trouble is displayed
[992]	View two-way PGM Supervision Trouble	PGM # in supervision trouble is displayed
[2850]	Assign RTX3	Assign the RTX3 that the sirens will be configured to
Note: The following programming sections correspond to sirens 1-8 EXAMPLE: [2852]: Learn Siren 2		

Section	Feature	Details
[2851] to [2858]	Learn Siren	Press and hold the Reset/Training switch for 3 seconds after entering the section to learn the siren WARNING: When pressing the Reset/ Training switch, the SR130/SR150 squawks and the strobe light flashes five times to confirm siren registration to the panel
[2861] to [2868]	Assign Partition to Siren	Assign sirens to either one partition or to all eight partitions. 00: Assigned to ALL 8 partitions 01-08: Assign to selected partition
[2871] to [2878]	Display Siren Signal Strength	Press and hold the Reset/Training switch for 3 seconds after entering the section to display the siren signal strength that the panel receives. Requires keypad K32LCD V1.3 and higher
[2870]	Temporary Siren Tamper Switch Deactivation for Maintenance	Press [ENTER] after entering the section to deactivate tamper alarm until the cover is reinstalled or after 30 minutes

RTX3 PGM Options for EVO

PGM Activation

PGM Number	Event Group	Feature Group	Start #	End #
PGM1	[910]	[911]	[912]	[913]
PGM2	[920]	[921]	[922]	[923]
PGM3	[930]	[931]	[932]	[933]
PGM4	[940]	[941]	[942]	[943]
PGM5	[950]	[951]	[952]	[953]
PGM6	[960]	[961]	[962]	[963]
PGM7	[970]	[971]	[972]	[973]
PGM8	[980]	[981]	[982]	[983]
Default Data	000	000	000	000

PGM Deactivation

PGM Number	Event Group	Feature Group	Start #	End #
PGM1	[914]	[915]	[916]	[917]
PGM2	[924]	[925]	[926]	[927]
PGM3	[934]	[935]	[936]	[937]
PGM4	[944]	[945]	[946]	[947]
PGM5	[954]	[955]	[956]	[957]
PGM6	[964]	[965]	[966]	[967]
PGM7	[974]	[975]	[976]	[977]
PGM8	[984]	[985]	[986]	[987]

Note For all events see PGM programming section in *EVO Programming Guide* (default data is set to 000).

PGM Number	PGM Delay	
	Delay (000-255)	Options
PGM1	[918]	[919]
PGM2	[928]	[929]
PGM3	[938]	[939]
PGM4	[948]	[949]

PGM5	[958]	[959]
PGM6	[968]	[969]
PGM7	[978]	[979]
PGM8	[988]	[989]
Default Data	005	OFF

The following options apply to sections [919], [929]... [989]:

Option [1]: PGM deactivation after:

See table on right

Option [2]: PGM base time:

ON: Minutes

OFF: Seconds (default)

Option [8]: Flexible PGM deactivation*:

See table on right











[1]	[8]	
OFF	OFF	Deactivation Event
OFF	ON	Deactivation Event
ON	OFF	PGM Timer
ON	ON	PGM Timer <u>or</u> Deactivation Event

* **Requirement:** To program "Flexible PGM deactivation" (option [8]) the "PGM deactivation after option" (option [1]) must be **ON**.

RTX3 Remote Control Programming for EVO

IMPORTANT: The following section **does not** apply to DGP series keypads.

Section	Feature	Details
[040] to [043]	View or Delete used Remote Controls	<p>Each section includes 8 positions corresponding to 8 remote controls programmed in the system (the system enables up to 32 remote controls). EXAMPLES: [040]: remote controls 1 to 8. [043]: remote controls 25 to 32</p> <p>To view/delete remote controls:</p> <ol style="list-style-type: none"> 1. Enter a section 2. Select the remote control position corresponding to the remote control to be deleted 3. Press [ENTER]. Any remote control position displaying * will be deleted

Section	Feature	Details
[201] to [232]	Assign Remote Controls to the System	Sections [201]-[232] correspond to remote controls 1-32 To assign remote controls to the system: 1. Enter a section 2. Press and hold a button on the remote control until you hear a confirmation beep. The remote control is assigned
[301] to [332]	Assign Remote Controls to Users	Sections [301]-[332] correspond to remote controls 1-32 To assign remote controls to Users: 1. Select a remote control: Enter a section. 2. Enter a User number (001 to 255) in the appropriate section (corresponding to Users 001 to 255)
[401] to [432]	Program / Modify Remote Control Settings	
	Sections [401]-[432] correspond to remote controls 1-32. ____ / ____ / ____ / ____ / ____ / ____ / ____ / ____ (Default: 15000000 - regular arm + disarm, see below)	
	   	N/A  N/A N/A
	   	N/A  N/A N/A
	[0]: Button disabled [1]: Regular arm [2]: Stay arm [3]: Instant arm [4]: Force arm [5]: Disarm [6]: Stay/instant disarm [7]: Panic 1 (Police) [CLEAR]: Exit without saving	[8]: Panic 2 (non-medical) [9]: Panic 3 (fire) [STAY]: Smoke reset [FORCE]: Utility key 1 [ARM]: Utility key 2 [DISARM]: Utility key 3 [BYP]: Utility key 4 [MEM]: Utility key 5 [ENTER]: Save data

Programming Stand-Alone RTX3 Modules

The RTX3 can be used as a Stand-Alone module. This section describes how to program the RTX3 in Stand-Alone mode.

Requirement

















Use a PX8 in conjunction with the RTX3 to program wireless transmitters in Stand-Alone mode (see the PX8 Instructions for more information).





To enter Programming mode:

1. Connect a 636 or 646 keypad to the **Program** connector (see #8 in [Figure 1 on page 5](#)).
2. Press the **Mode Programming** button (see #7 in [Figure 1 on page 5](#)).
3. Press **[ENTER]** on the Esprit keypad.
4. Enter the installer code (default: 757575).
5. Enter the required section number.

Stand Alone Programming

Section	Feature	Details
[000]	Installer Code	Set installer code (4 or 6 digits. Default: 757575)
[004]	PGM Initial State	
	Option	
	[6]	PGM1 initial state OFF: Normally open (default) ON: Normally closed
	[7]	PGM2 initial state OFF: Normally open (default) ON: Normally closed
[201] to [232]	Remote Control Assignment	Sections [201]-[232] correspond to remote Controls 1- 32 To assign a remote control: 1. Press [ENTER] . 2. After the confirmation beep, press and hold any button on the remote until you hear two beeps. To delete a remote control: Press [2ND] followed by [ENTER] .

Section	Feature			Details
[401] to [432]	Remote Control Button Options			
	Sections [401]-[432] correspond to remote controls 1-32.			
	Option			
	[1]	[2]	[3]	Definition*
	OFF	OFF	OFF	No Arm or Disarm
	ON	OFF	OFF	 Regular Arm (default)
	OFF	ON	OFF	 Regular Arm
	ON	ON	OFF	 Regular Arm
				 Regular Arm
	OFF	OFF	ON	 Force Arm
	ON	OFF	ON	 Force Arm
				 Stay Arm
OFF	ON	ON	 Regular Arm	
			 Stay Arm	
ON	ON	ON	 Stay Arm	
* Buttons used to arm the system are also used to disarm the system				
Option				
[4]	To select PGM see section [011]		Enable button  for PGM activation Default: ON	
[5]	To select PGM see section [012]		Enable button  for PGM activation Default: ON	
[6]	To select PGM see section [013]		Enable button  for PGM activation Default: ON	
[7]	To select PGM see section [014]		Enable button  for PGM activation Default: ON	
[8]			Enable button  +  for Panic Alarm (default: ON)	

Section	Feature	Details	
[011] to [014]	PGM Output Activation [011]: Remote Button  [012]: Remote Button  [013]: Remote Button  [014]: Remote Button 	See sections [401] to [432]	
	Option		
	[1]	Activate PGM 1 output	Default ON in section [011]
	[2]	Activate PGM 2 output	Default ON in section [012]
	[3]	Activate PGM 3 output	Default ON in section [013]
	[4]	Activate PGM 4 output	Default ON in section [014]
[021] to [024]	PGM Latch / Delay		
	Sections [021]-[024] correspond to PGMs 1-4		
	Option		
	[0]	Latched	
	[1]	1 second	
	[2]	5 seconds	(default)
	[3]	10 seconds	
	[4]	20 seconds	
	[5]	40 seconds	
	[6]	60 seconds	
	[7]	2 minutes	
[8]	4 minutes		

Section	Feature		Details	
[002]	PGM Output on Panic			
	Option			
	[0]	No PGM output on panic alarm		
	[1]	Toggle PGM 1 on panic alarm		
	[2]	Toggle PGM 2 on panic alarm		
	[3]	Toggle PGM 3 on panic alarm		(default)
	[4]	Toggle PGM 4 on panic alarm		

Firmware Upgrade

Upgrade RTX3 firmware using either a serial connection or a four-wire connection.

For firmware upgrade instructions see the *Firmware Upgrade Instructions* document at: Paradox.com > Software > BabyWare.

Index

Sections

2WPGM	
<i>Assigning</i>	14
<i>Signal strength</i>	13

A

Antenna installation	8
Antennas	6
Anti-tamper switch	6
Approvals	4
Assign partition to siren.....	14
Assign RTX3.....	14
Assign wireless transmitters	13

B

Battery life	13
--------------------	----

C

Check-in supervision	12
Check-in supervision time interval	12
Code length	19
Compatibility	4
Consumption	4
Current battery life	13
Current consumption	4

D

Dimensions	4
Display Siren Signal Strength.....	14

E

EN50131	4
Esprit	17
Esprit mode	6
EVO	11

F

Firmware upgrade	20
Frequency	4

I

Imperial	10
Input voltage	4
Installation	7
Installer code	17

K

K641	11
------------	----

L

Learn Siren.....	14
LED display	6
LED feedback	6, 9
Low battery supervision	12

M

Module programming mode (EVO)	11
Mounting clips	6

O

On-board module tamper supervision	12
Operating temperature	4

P

Panic alarm	19
PGM	
<i>Activation</i>	14
<i>Deactivation</i>	15
<i>Delay</i>	15
<i>initial state</i>	12, 17
<i>Latch / delay</i>	19
<i>Options for EVO</i>	14
<i>Output activation</i>	19
<i>output on panic</i>	20
<i>outputs</i>	4
<i>Programming</i>	14
<i>Supervision trouble</i>	14
<i>Tamper trouble</i>	14
Power input voltage	4
Previous battery life	13
Programming	10
Programming button	6

R

REM2 visual and auditory feedback	12
---	----

Remote control assignment	17
Remote control button options	18
Remote controls	13
Reset	8
RF Jamming supervision	12
RF lockout on panic	20

S

Sensitivity	4
Signal strength	13
Specifications	4
Spectra SP series	10
Stand alone	17, 20
System reset	8

T

Temperature	4
Temporary Siren Tamper Switch Deactivation.....	14
Transmitter signal strength	13
Transmitter tamper signal	12

U

User code assignment	17
----------------------------	----

V

View serial numbers	12
Voltage	4

W

Warranty	24
Wireless transmitter supervision options	11
Wiring slot	6

Patents

One or more of the following US patents may apply: 7046142, 6215399, 6111256, 6104319, 5920259, 5886632, 5721542, 5287111, 5119069, 5077549 and RE39406 and other pending patents may apply. Canadian and international patents may also apply.

Trademarks

EVO and Spectra SP Series are trademarks of Paradox Ltd. or its affiliates in Canada, the United States and/or other countries.

Certification

For the latest information on products approvals, such as UL and CE, please visit www.paradox.com.

Warranty

For complete warranty information on this product please refer to the Limited Warranty Statement found on the website www.paradox.com/terms. Your use of the Paradox product signifies your acceptance of all warranty terms and conditions.

© 2013 Paradox Ltd. All rights reserved. Specifications may change without prior notice.

Technical Support

For technical support in Canada or the U.S., call 1-800-791-1919, Monday to Friday from 8:00 a.m. to 8:00 p.m. EST. For technical support outside Canada and the U.S., call 00-1-450-491-7444, Monday to Friday from 8:00 a.m. to 8:00 p.m. EST.

For additional information please visit our website at www.paradox.com.

For technical support in Canada or the U.S., call 1-800-791-1919,
Monday to Friday from 8:00 a.m. to 8:00 p.m. EST.
For technical support outside Canada and the U.S.,
call 00-1-450-491-7444, Monday to Friday
from 8:00 a.m. to 8:00 p.m. EST.

Please feel free to visit our website at www.paradox.com