

AUTOMATISM FOR OVERHEAD DOORS

ASSEMBLY AND USER'S MANUAL



Please read this instructions very
carefully before assembly

A) Warning to the installer

 Before the installation of the automatism, spring must be tuned to the weight of the gate, so that it can be opened and closed by hand.

- 1) CAUTION: It is important to your safety that these instructions are followed. The installation or misuse of this product may cause damage and injury.
- 2) Keep these instructions in a safe place for future reference.
- 3) This product was designed and produced strictly for use indicated in this manual. Any other use other than as expressly levels may damage the product and / or be a source of danger, and lose the warranty.
- 4) The STATEUROP is not responsible for incorrect use of the product, or the use other than that for which it was designed.
- 5) Do not install the product in an area where there is danger of explosion: gas or flammable fumes are a serious security threat.
- 6) The STATEUROP is not responsible if the safety standards not taken into account in the manufacture of the element to be automated or any deformation that may occur to it.
- 7) Before the installation, turn off the power supply.
- 8) The safety devices (ex: photocells) should be used for prevent injury and / or materials.
- 9) The STATEUROP is not responsible for the safety and proper operation of the product when used components that sold by itself.
- 10) Do not make any changes to engine components and / or accessories.
- 11) The installer should inform the customer how to operate the product emergencies and provide its user.
- 12) Do not let children approach the moving parts of the door automatically when they are in motion.
- 13) Keep the commands out of reach of children, so prevent the automatic operate accidentally.
- 14) The client shall in no circumstances attempt to repair or tune the automation, and for this purpose call a Technical qualified.

15) The automatism must be installed in order to be protected from elements. Exposure to water, rain, humidity or excessive dust may void the warranty of the product.

16) Turn on the automatic to a 230V outlet protected with ground wire.

17) For the function of closing shall be installed photocell.

18) Operator for indoor use.

Loosening:



The pulley block was designed for emergency use situations only, so avoid to use it continuously

B) Specifications:

1) Engine Specifications

Model	50	100	400
Input	AC230V, 50Hz	AC230V, 50Hz	AC400V, 50Hz
Power	450W	550W	750W
Intensity	≤ 6A	≤ 10A	≤ 2A
Capacitor	30μF	40μF	-
Work Frequency	2/min.	2/min.	2/min.
Heat protection	120°C	120°C	120°C
Temperature	>-20°C; <+50°C	>-20°C; <+50°C	>-20°C; <+50°C
Máx.Height	7m	7m	7m
Máx.Torque	50N	100N	110N
RPM	24rpm	24rpm	24rpm

1) Control board Specifications:

Model	230V	400V 3x230V AC + N
Input	AC230V, 50Hz	AC400V, 50Hz (With neutral)
Intensity	AC24V 0,2A	AC24V 0,3A
Output	5W	10W
Temperature	<-50°C; <+50°C	<-50°C; <+50°C

G) Use and maintenance:

- There are switch buttons (one Emergency Stop, one Open button and one Close button) on the controller. Press the Emergency stop button, the running doors stop immediately and shut off power supply. Turn the button according to direction marked to reposit the button.
- Ordinary operation: User could control the door by pressing the open or close button on controller. When the door is moving, press any button to make it stop.
- Termly check the balance of extension spring and the torsional force to ensure the door could move up/down smoothly by manual force

H) Problems/Solutions:

Number	Trouble	Possible cause	Troubles shooting
1	Motor can't turn on	<ul style="list-style-type: none"> ● No power supply ● Fuse IS broken ● Capacity is broken down ● overload protect ● overheating protect ● microswitch is inoperative 	<ul style="list-style-type: none"> ● Check power supply ● Change fuse ● Change capacitor ● Check if any barrier on the rack ● Restart after 20 minutes ● Pull the hand chain
2	Open(close) but can't close(open)	<ul style="list-style-type: none"> ● whether L1, COM, L2 wires are connected wrong 	<ul style="list-style-type: none"> ● connect correctly according to wiring diagram
3	Can not limit position	<ul style="list-style-type: none"> ● limit switch is damaged ● limit switches wires poorly connected 	<ul style="list-style-type: none"> ● change the limit switch ● change limit switches wires
4	Pulley do not work	<ul style="list-style-type: none"> ● The gears are damaged ● The spring in gear reducer is damaged 	<ul style="list-style-type: none"> ● turn the gear double direction ● change the axis
5	Push "open", but the door is down	<ul style="list-style-type: none"> ● whether L1, L2wires are connect wrong 	<ul style="list-style-type: none"> ● connect according to wiring diagram
6	Motor can turn but operator not work	<ul style="list-style-type: none"> ● Spring in gear reducer ● Whether gears are released 	<ul style="list-style-type: none"> ● change or adjust stress of spring ● check the position of handle

C) Product Description:

1) 50 /100

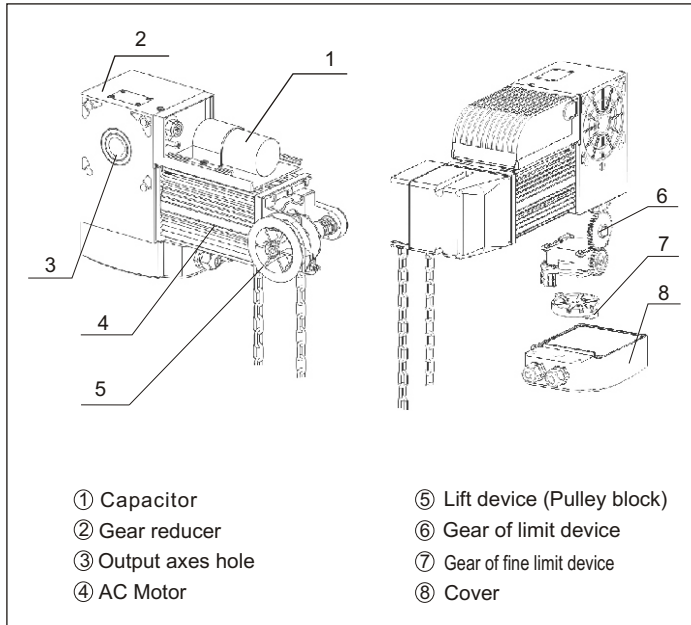

2) Accessories

Imagem	Nome	Espec.	Qtd.
	Mounting bracket		1
	Straight key	6 x 100	1
	Expand bolt	M10	6
	Socket cap screw	M10 x 20	8
	Screw	M8 x 12	1
	Coil spring washer	Ø 10	8
	Flat washer	Ø 10	8
	Flat washer	Ø 8	1

2.2. Product explanation

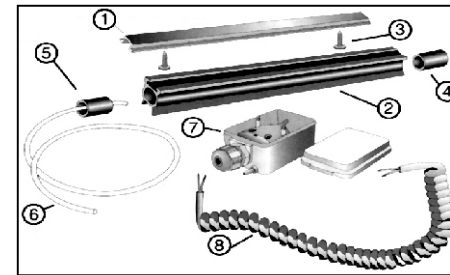
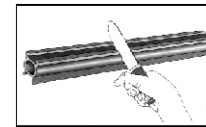
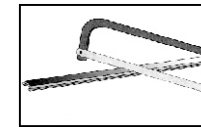

Fig 6.3

2.3. Installation



1)cut the rubber tube into proper length as you need.



2)cut the aluminium groove into proper length as you need.

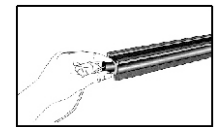

3)put the seamless hollow plug and PVC soft tube into rubber tube.

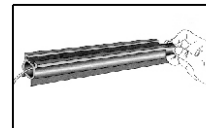

4)put the seamless solid plug into rubber tube.

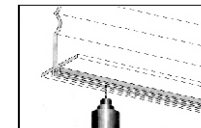

5)fix up the aluminium groove.

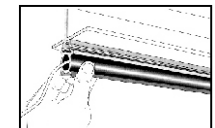

6)put the Rubber tube which is well assembled into aluminium groove.

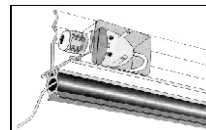

7)Install the Air wave electric switch.

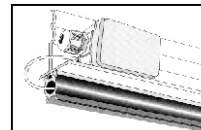

8)connect the PVC soft tube with switch.

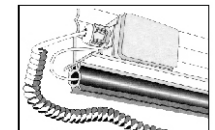

9)connect spiral cable with controller.

D) Assembly:



Before the installation of automatism, the door must be completely placed and tuned springs.

1) Appearance of a standard application:

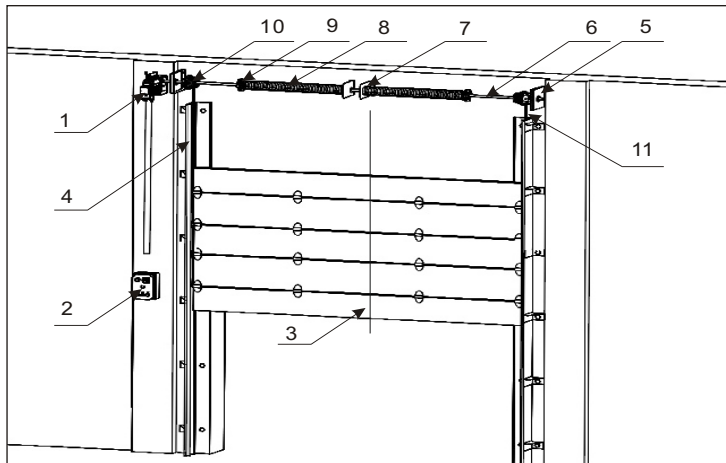

- | | |
|---------------|------------------------------|
| ① KVM | ⑥ Tube axle |
| ② Control box | ⑦ Fixer for torsion spring |
| ③ Door | ⑧ Torsion spring |
| ④ Track | ⑨ Bracket for torsion spring |
| ⑤ Bracket | ⑩ Wire step pulley |
| | ⑪ Steel wire |

2) Motor mounting:

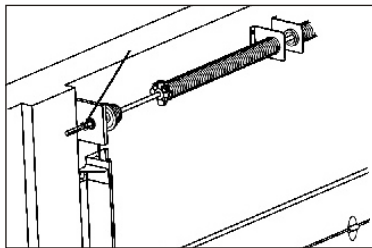

① Let the spring come with the least 35cm outside the poly

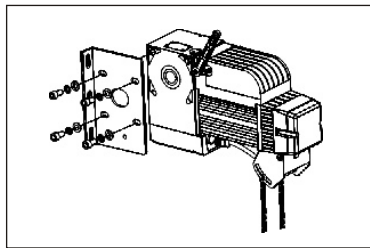

② Point the plate to the motor

OPTIONAL SAFETY DEVICES

F) Installation:

1. Photocells installation:

- (1) Photocells should be installed at the two sides of the door frame, 100mm height from the ground.
- (2) Switch off the power, connect Beam receiver and Beam emitter with the controller. Switch on power, adjust carefully the location of Beam receiver and Beam transmitter, the beam of Receiver and Emitter should aim at each other. The red-light in receiver is dim, while the beams collimate, then, the door operator could work normally.
- (3) Fixed by screw to ensure that the photocell would not shift easily.

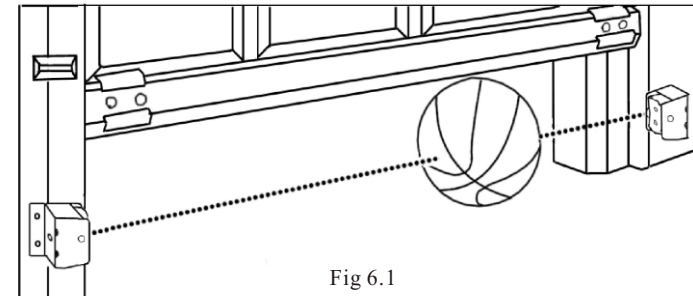

Fig 6.1

2. Installing Air Wave Switch

- 2.1. Working principle: the power from the air compression soft tube transportation to Air wave switch

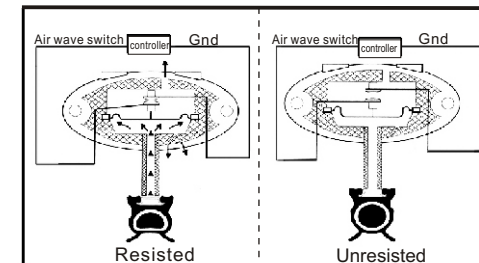
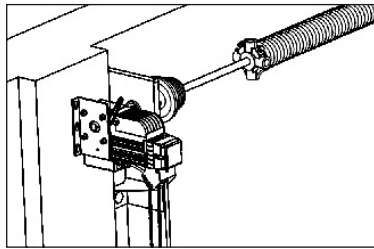
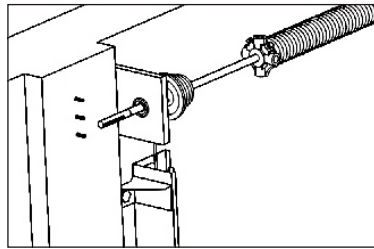

Fig 6.2



③ Place the motor shaft and springs make the markings of the holes



④ Remove the engine and make holes 10mm in marking

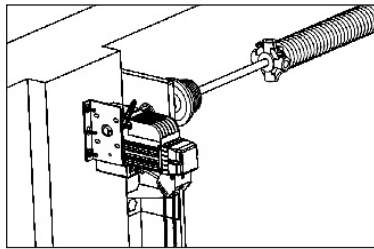

⑤ Replace the engine in place and attach the bracket to the wall

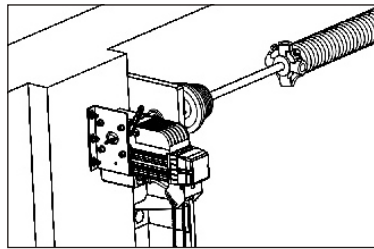

⑥ Put the brake to coincide with the shaft and spring engine

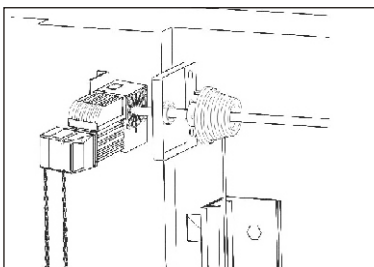

⑦ Tighten the screws from support the engine and the wall

5.1 Set the closing limit

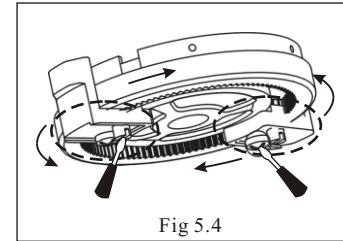

Fig 5.4

Step 1 - Close the door completely, and confirm which is the one of close limit block according to the situation , then loosen the screw adjuster on close limit block

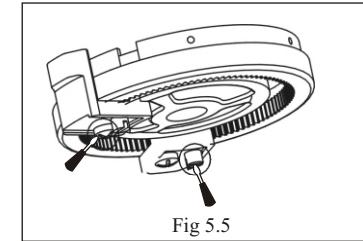

Fig 5.5

Step 2 - Adjust the fine adjuster till the close limit block touch the microswitch and LED4 on control box turn off

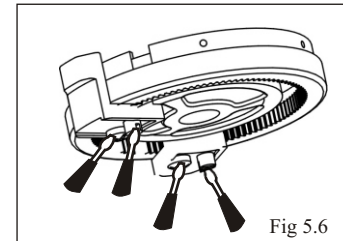

Fig 5.6

Step 3 - Fasten the screw adjuster on close limit block

Step 4 - Start the operator ,inspect if the close limit points is in accoed with door closed totally.If not ,readjust from step 2.

Attention: If the motor work in the wrong way change the connetions L1 and L2.

5.2 Set «open» limit switch

Do the same that you do to set the «closing» limit switch

3) Fix the control box in the wall

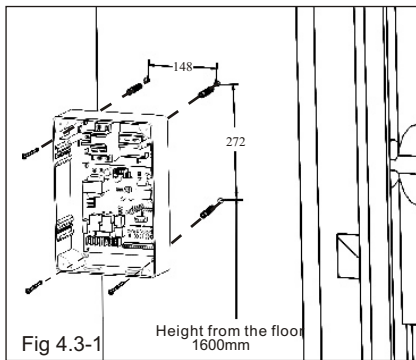
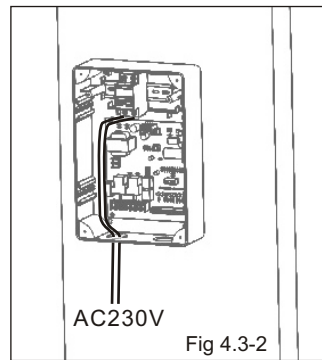

Fig 4.3-1

Height from the floor
1600mm



AC230V

Fig 4.3-2

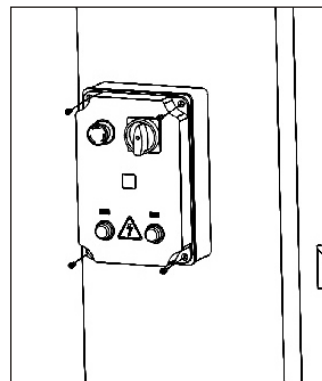
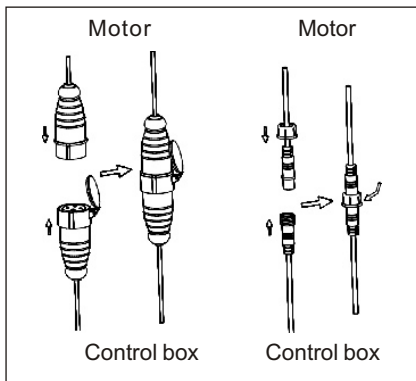

E) Control box:

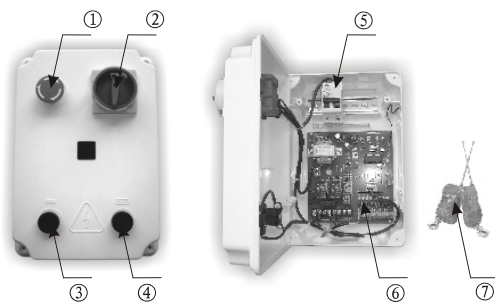
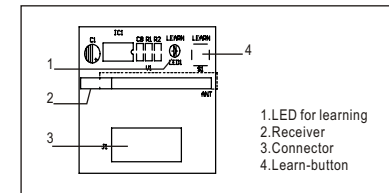

Fig 5-1 Control box

- ① Emergency button
- ② Switch ON / OFF
- ③ Close button
- ④ Open button
- ⑤ Interrupter
- ⑥ Control box
- ⑦ Remote control

4. Erase the codes

Press «LEARN» for 8 seconds until the LED1 flash. After this, all the codes were eliminated



5. Ending-switth set

If the engine star work in the wrong way, you should change the connections like we show in the picture.

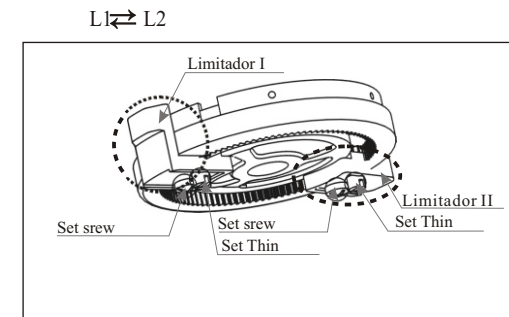

Control board wiring diagram

1. 230VAC Control Box

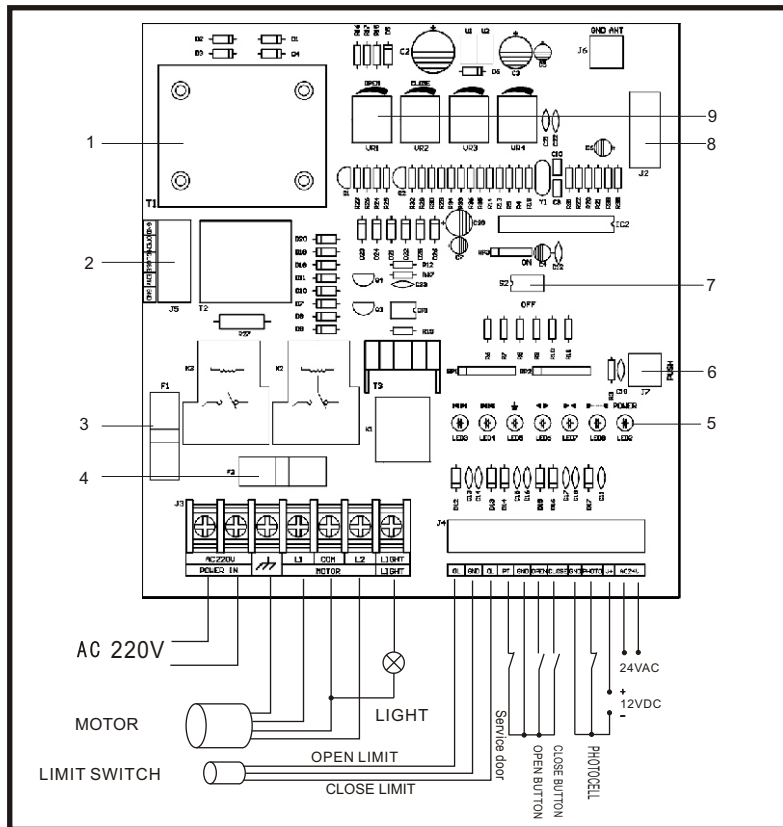

Technical data

Supply	AC 230V 50HZ
Max. Consumption	3W
Accessories power supply	AC24V 0.4A max
Operating temperature range	-20°C ~ +55°C
Operating mode	Soft start & stop
Frequency	433MHZ

Description of main board

1. Transformer
 2. Button connector
 3. 0.2A Fuse
 4. 8A Fuse
 5. LED
 6. Push button connector
 7. DIP switch
 8. Receiver module connector
 9. Potentiometer
- Vr1: Potentiometer for adjust opening force
 Vr2: Potentiometer for adjust closing force
 Vr3: Potentiometer for adjust auto closing time
 Vr4: Potentiometer for adjust running time

2. DIP Switches setup



- DIP1: ON: Enable auto closing ,delay time is adjustable when rotating Vr1 potentiometer
 OFF: Disable auto closing
 DIP2: ON: Human mode , the button should be pressed continuously when closing door
 OFF: Automatic mode

LED-R } Fase
 LED-S }
 LED-T }

- LED1: Learning
 LED2: Power
 LED3: Opening Limit
 LED4: Closing Limit
 LED5: Stop
 LED6: Air wave
 LED7: Opening
 LED9: Closing
 LED10: Photocells

3. Add remote control

Press «LEARN» for 1 second ,the Led1 flash ,press one button from transmitter ,the LED1 flash 2 times and the button is programmed

NOTE: The operating mode of the transmitter is step by step for each button

2. DIP Switches setup

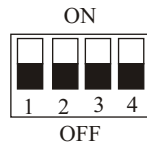

- DIP1: ON: Enable auto closing ,the delay time is adjustable when rotating Vr3
OFF: Disable auto closing
- DIP2: ON: Human mode , the button should be pressed continuously when closing door
OFF: Automatic mode
- DIP3: ON: Enable force detecting,in this situation ,when the door meets obstacle , it will reverse.The force can be adjusted by Vr1 and Vr2
OFF: Disable force detecting
- DIP4: ON:Enable soft start&stop
OFF: Disable soft start&stop

- LED1: Learning
LED2: Power
LED3: Opening limit
LED4: Closing limit
LED5: Air wave
- LED6: Opening
LED7: Closing
LED8: Photocells

3. Add remote control

Press «LEARN» for 1 second ,the Led1 flash ,press one button from transmitter ,the LED1 flash 2 times and the button is programmed

NOTE: The operating mode of the transmitter is step by step for each button

1. 400VAC Control board

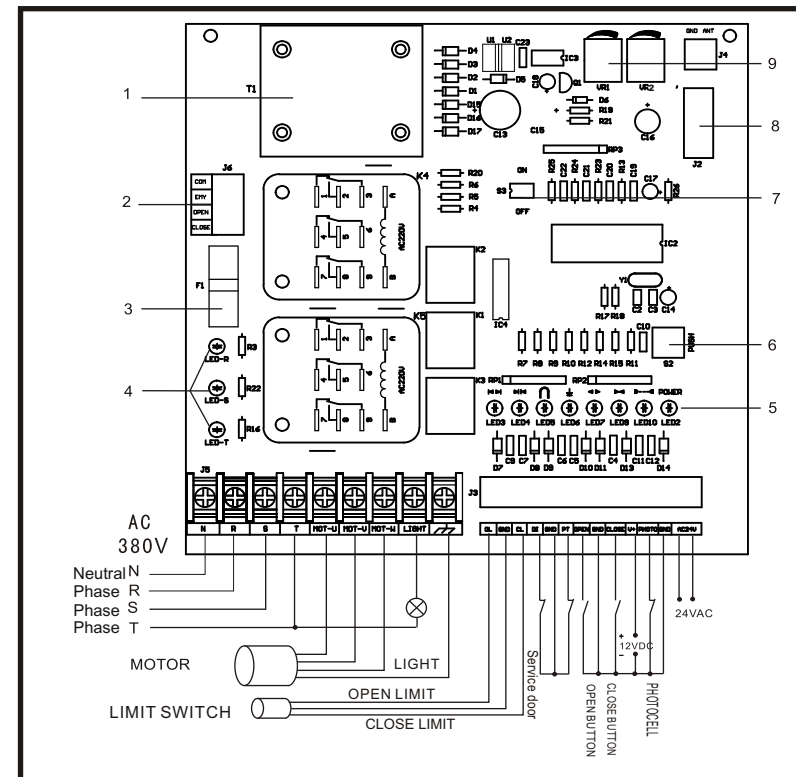

Technical Data

Supply	3X230V + N
Max. Consumption	3W
Accessories power supply	AC24V 0.4A max
Operating temperature range	-20°C ~ +50°C
Frequency	433MHZ

Discription of main board

1. Transformer
 2. Button connector
 3. 2A fuse
 4. LED
 5. LED
 6. Push button
 7. DIP switch
 8. Receiver
 9. Potentiometers
- Vr1: Potentiometer for adjust running time
Vr2: Potentiometer for adjust pause time